

1		<p>1</p> <p>P35-P37</p> <p>2</p> <p>P32</p>
2	" "	<p>1</p> <p>" "</p> <p>P19-P28</p> <p>2</p> <p>P34 2-5</p> <p>P31-P35</p>
3	" "	<p>1</p> <p>P55-P78</p> <p>P41</p> <p>P44-P45</p> <p>P49-P52</p> <p>2</p> <p>P55-P56</p> <p>P67-P68</p> <p>P66</p> <p>3</p> <p>P75-P76</p> <p>2-1</p> <p>"</p> <p>P77-P78 P82-P85</p>

4		<p>1 P14 P18</p> <p>2</p> <p>P121-P122</p>
5		<p>1 P153- P156</p> <p>2 P54</p> <p>3 P166-P173</p> <p>4</p> <p>P168-P173 P129-P131</p> <p>5 P98-P99</p>
6		<p>1 P184-P185</p> <p>2</p>

1	1
1.1	1
1.2	1
1.3	2
1.4	3
1.5	3
2	4
2.1	4
2.2	7
2.3	8
2.4	10
2.5	17
2.6	19
2.7	24
2.8	28
2.9	31
2.10	34
2.11	35
3	38
3.1	38
3.2	38
3.3	47
3.4	52
3.5	53
3.6	54
3.7	54
4	55
4.1	55

4.2	57
4.3	61
4.4	78
4.5	82
5	86
5.1	86
5.2	89
6	99
6.1	100
6.2	106
6.3	127
6.4	131
7	145
7.1	145
7.2	149
7.3	150
7.4	150
7.5	153
7.6	159
7.7	166
8	174
8.1	174
8.2	174
8.3	181
8.4	184
9	186
9.1	186
9.2	186
9.3	186
9.4	189

9.5	191
9.6	194
10	196
10.1	196
10.2	199
11	203
11.1	203
11.2	203
11.3	204
11.4	205
12	206
12.1	206
12.2	206
12.3	206
12.4	207
12.5	210
12.6	210
12.7	211
12.8	211

1

2-1

2-2

2-3

2-4

2-5

3

4

5

6

7

8

9

10

11

12

13

1

2

[2018-511825-12-03-249048]FGQB-0025

3

C5118252018057130146161

4

91511825MA64KMCM73

5

[2018]36

6

[2018]67

7

[2018]28

8

9

10

[2018]135

11

[2019]159

12

13

14

[2019]5

15

16

17

1

10000

“ ” “ ”

“ ”

2018 5 2

C5118252018057130146161

60 /

0.4448

10

0.4448

60

GB/T 4754-2017

253

“

137

”

“

”

“ ”

[2018]135

” ”

” ”

HJ2.1-2016

1.2-1

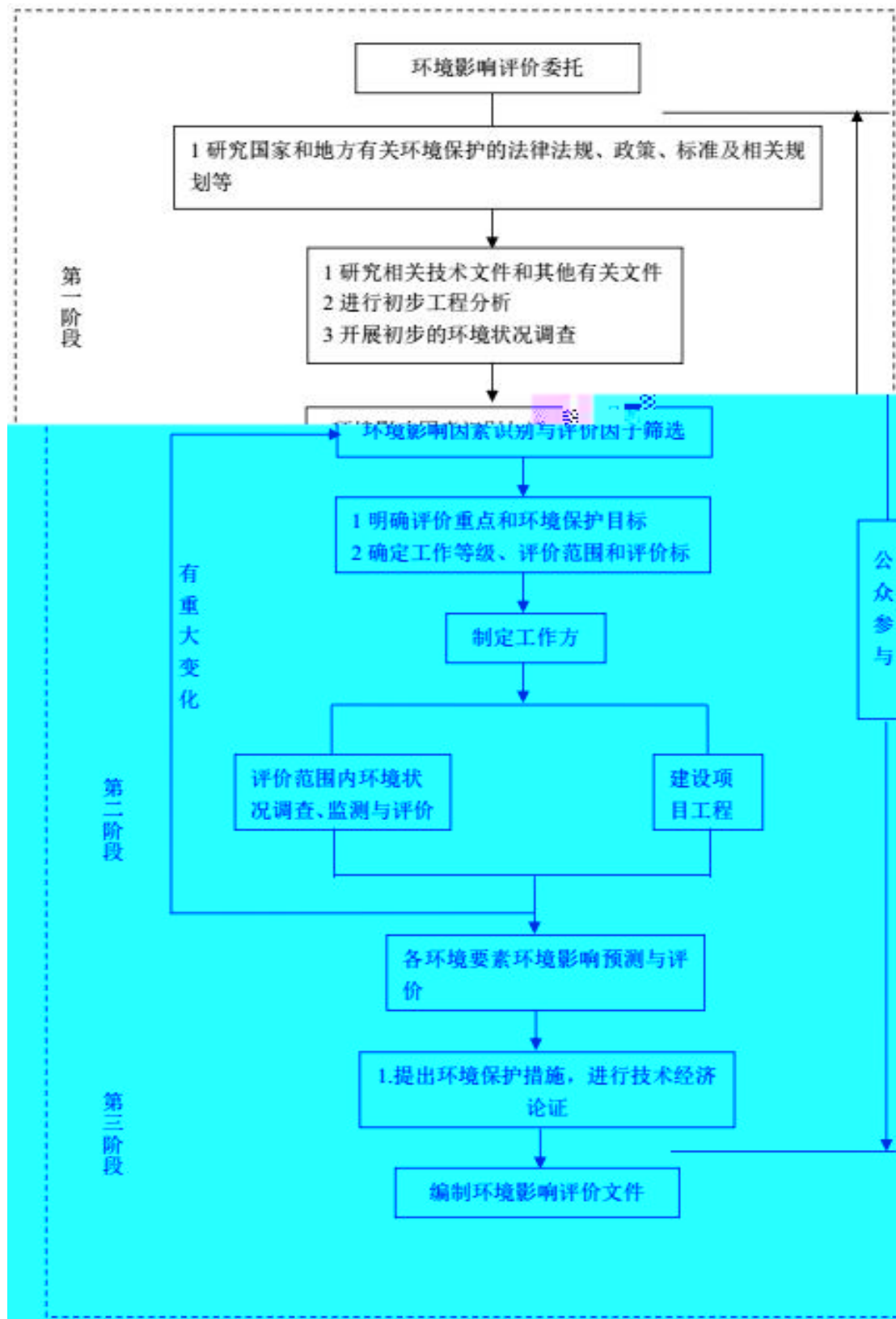

2011

[2005]40

2

3

1

2

3

4

5

“ ”



1 2014 2015 1 1
2 2016 9 1
3 2016 1 1
4 2018 1 1
5 1997 3 1 2018
12 29
6 2016
7 2009 8 29
8 2012
9 2011 3 1
10 682 2017 10 1
11 [2006]28

12 2019 1 1
13 [2000]38 2000 11 26
14 2017 6 29
44 2018 4 28 <
>
15 2000.11.16
16
2012
2012
2012.5.23
17 2016 2
18 2015 3
19 1997 1 1
20

2015 61
21 “ ”
1
[2014]30
2 [2015]17
2015.4.2
3 [2007]37
4
[2012]77
5 [2012]98
6
[2010]144
7 592 2011 3 5
8 2012 12 11
9 [2005]39
10 [2008]3
11 [2011]35
12
[2010]33
13 [2001]19
14 [2004]24
15 [2005]109
16
[2012]77
17 2011 2013

18		[2013]37
19		[2015]17
20		[2016]31
21		
[2018]24		
22		
23		
24	“ ”	2016-2020
25		2016-2020
1	—	HJ 2.1-2016
2	—	HJ 2.2-2018
3	—	HJ 2.3-2018
4	—	HJ 610-2016
5	—	HJ 2.4-2009
6	—	HJ 19-2011
7		HJ 964-2018
8		HJ 169-2018
9		HJ 616-2011
10		GB 18218-2018
11		HJ 192-2015
12		HJ 651-2013
13		GB 50433-2008
1		
2		[2018-511825-12-03-249048]FGQB-0025
3		C5118252018057130146161
4		91511825MA64KMCM73
5		

[2018]36

6

[2018]67

7

[2018]28

8

9

10

[2018]135

11

[2019]159

12

13

14

[2019]5

15

16

17

18

19

“ ”

“ ”

“

”

2.3-1

			L _d Ln
			L _d
			pH

1

—

HJ 2.2-2018

P_i

i

10%

D_{10%}

P_i

$$P_i = \frac{C_i}{C_{0i}} \times 100\%$$

P_i— i

%

C_i—

i

mg/m³

C_{0i}— i

mg/m³

GB3095 1

5.2

1k m"

		900	GB3095-2012
--	--	-----	-------------

2

-

HJ2.2-2018

Aerscreen

/	/	/	/
/	/	34.8	
/	/	-1.8	
			√
	/m	/	
			√
	/km	/	
	/°	/	

3

1	10	0.011343	1.26	10	0.027824	3.09
2	25	0.011556	1.28	25	0.0336	3.73
3	50	0.011904	1.32	50	0.043691	4.85
4	75	0.012245	1.36	75	0.051442	5.72
5	100	0.012577	1.4	100	0.052282	5.81
6	125	0.012903	1.43			
7	150	0.013221	1.47	125	0.052679	5.85
8	175	0.013534	1.5	150	0.049338	5.48
9	200	0.013839	1.54	175	0.044965	5.00
10	225	0.014137	1.57	200	0.040241	4.47
11	250	0.014429	1.6	225	0.039878	4.43
12	275	0.014714	1.63	250	0.039779	4.42
13	300	0.014993	1.67	275	0.039369	4.37
14	325	0.015268	1.7	300	0.038761	4.31
15	350	0.015536	1.73	325	0.038007	4.22
16	375	0.015798	1.76	350	0.037144	4.13

17	400	0.016056	1.78	375	0.036204	4.02
18	425	0.016309	1.81	400	0.035262	3.92
19	450	0.016555	1.84	425	0.034256	3.81
20	475	0.016797	1.87	450	0.033269	3.70
21	500	0.017036	1.89	475	0.03231	3.59
22	525	0.017271	1.92	500	0.031339	3.48
23	550	0.017497	1.94	525	0.030396	3.38
24	575	0.017721	1.97	550	0.029495	3.28
25	600	0.017941	1.99	575	0.028612	3.18
26	625	0.018159	2.02	600	0.028105	3.12
27				625	0.027643	3.07
28	650	0.018317	2.04	650	0.02719	3.02
29	675	0.01823	2.03	675	0.026736	2.97
30	700	0.018089	2.01	700	0.026285	2.92
31	725	0.017883	1.99	725	0.025846	2.87
32	750	0.017632	1.96	750	0.025399	2.82
33	775	0.01735	1.93	775	0.024964	2.77
34	800	0.017044	1.89	800	0.024538	2.73
35	825	0.016726	1.86	825	0.024121	2.68
36	850	0.016402	1.82	850	0.023716	2.64
37	875	0.016078	1.79	875	0.023315	2.59
38	900	0.015756	1.75	900	0.022921	2.55
39	925	0.015438	1.72	925	0.022611	2.51
40	950	0.015115	1.68	950	0.022326	2.48
41	975	0.014795	1.64	975	0.022045	2.45
42	1000	0.014486	1.61	1000	0.021761	2.42
43	1025	0.014182	1.58	1025	0.021482	2.39
44	1050	0.013889	1.54	1050	0.021212	2.36
45	1075	0.013604	1.51	1075	0.020945	2.33
46	1100	0.013329	1.48	1100	0.020683	2.30
47	1125	0.013058	1.45	1125	0.020424	2.27
48	1150	0.012795	1.42	1150	0.020168	2.24
49	1175	0.012537	1.39	1175	0.019919	2.21
50	1200	0.01229	1.37	1200	0.019675	2.19

AERSCREEN

$P_{\max}=2.04\%$

5km

$P_{\max}=5.9\%$

5km

HJ 2.3-2018

2.4-5

		Q 2000 W 600000
A		Q<200 W<6000
B		/
1		A
2		
3		
4		
5		
6		
7		500 m ³ /d
500 m ³ /d		
8	A	
9	B	
10		B

B

GB/T14848-2017

HJ 610-2016

A“

HJ2.4-2009

1	GB3096	0 5dB(A) (5dB(A))
2	GB3096	1 2 3dB(A)~5dB(A)(5dB(A))
3	GB3096	3 4 3dB(A)(3dB(A))
GB3096-2008 2		

3dB(A)

	2	3dB(A)	

HJ19-2011

[2018]

135

50km 0.4448km² 2km² 1.5km

HJ 964-2018

1

	^a >2.5	pH 4.5	pH 9.0
	<1.5m >4g/kg		
	1.5m >2.5 1.8< 2.5 <1.8m >2.5	4.5<pH 5.5	8.5 pH<9.0
	<1.5m 2g/kg< 4g/kg		
		5.5<pH<8.5	
^a	E601		

2

			-
	" "		

pH

5.5~8.5

A

" "

HJ 169-2018

	+			
				*

A

1

E1	+			
E2				
E3				

+

P

B

Q

M

C

P

E

D

E

2

P

HJ 169-2018

C

Q

$$Q = q_1/Q_1 + q_2/Q_2 + \dots + q_n/Q_n$$

$q_1 \quad q_2 \dots q_n$ —

t

$Q_1 \quad Q_2 \dots Q_n$ —

t

Q 1

Q 1 Q 1 1 Q 10 2 10 Q 100 3 Q 100

54t

1.5t

B

2500t

Q 1

C.1

M

M4

P

P4

E

HJ 169-2018

D

E3

E3

E3

E3



- 1
- 2
- 3

0.4448km² 44.48hm²

500m

200m

HJ

2.2-2018

5km

5km

HJ 2.3-2018

B

1

2

HJ 169-2018

500m

3500m

4km

—

HJ 2.4-2009

200m

200m

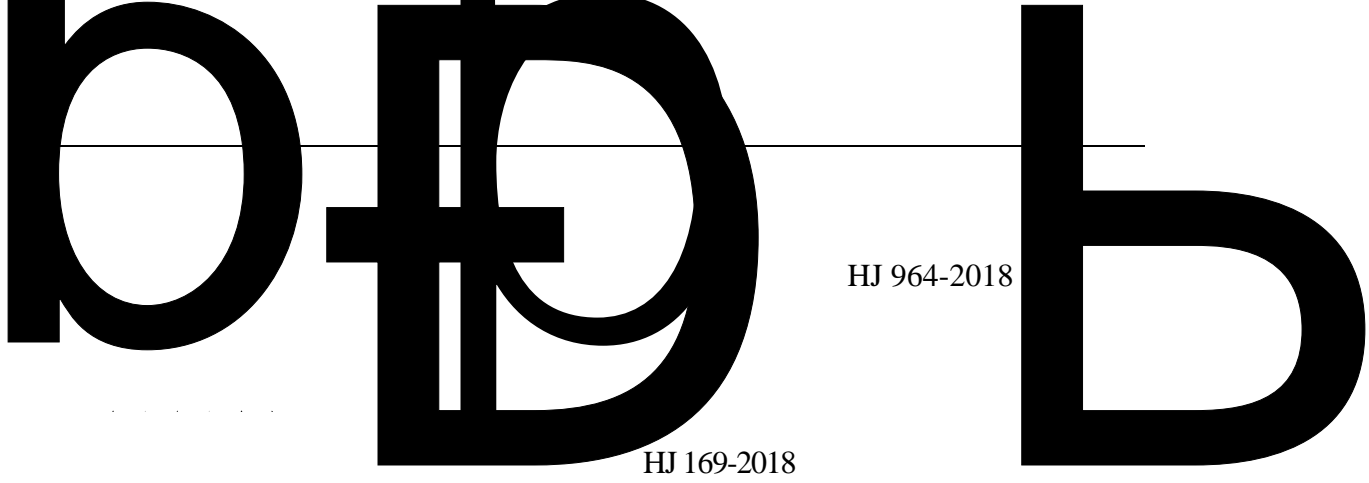

“B1019
2013

”

GB/T 4754-2017
2011

[2005]40

“

”

[2018-511825-12-03-2490

48]FGQB-0025

9

[2014]17

“

”

“

/

30

/

50

/

100

/

”

60

1	1		
	2		
	3		
	4		
	5		
	1		
	2		
2	3		
	4		
	1	—	—
	2	—	—
3	6		
	1		

1

1

()

()

2

4

3

3	“ ”	“ ”	
4			
5			
6			
7			
8	<p style="text-align: center;">30cm</p> <p style="text-align: center;">20cm</p> <p>20cm</p> <p>20cm</p>		

2.6.2

HJ651-2013

“ ”

“ ”

“ ”

1			
2			
3			
4			
5			
6			
7			
8			
9			
10			

2.6-3

“

”

2011

21

[2005]109

HJ651-2013

11.7km

1			
2			

1	2-2 - - 0.86 km ²	5	

2016-2020

2018 24

				"	"
—	—				
					0.63
		4.26%		1.30%	
					2
	4		3	3	
1		1	1	1	

[2018]67

[2018]28

[2019]159

2018 24

3 4 5 6 7 8 9 10 11 12

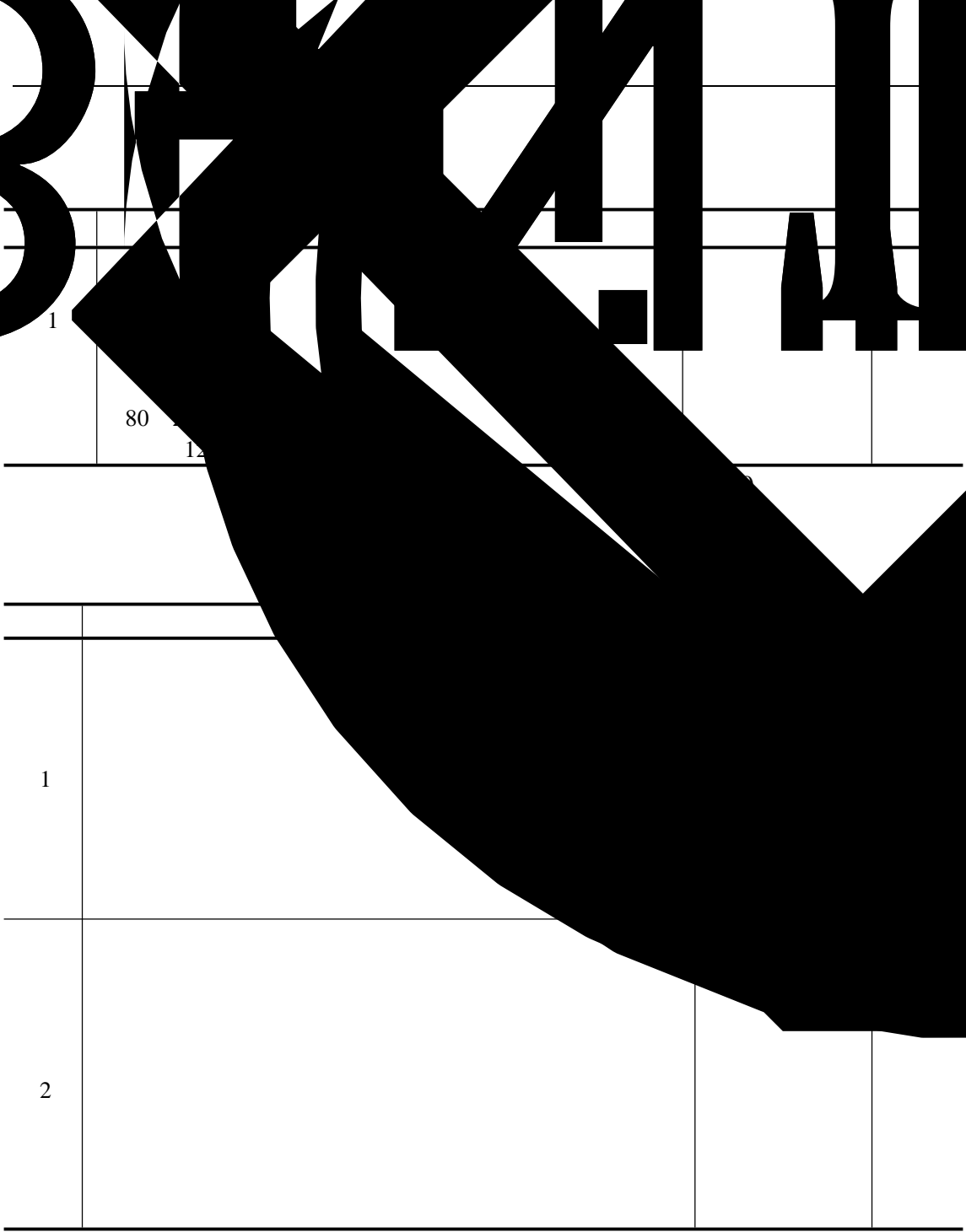

=



—
—

1

1600

—

1

[2018]67

80

27134

20177

4

12

[2019]159

[2018]28

2018 24

2016-2020

2016-2020

GB

3095-2012

2.8-1

TSP	200	300	/		
PM ₁₀	70	150	/		
PM _{2.5}	35	75	/		
SO ₂	60	150	500		
NO ₂	80	80	200		
CO	/	4	10		
O ₃	/	160	200	8	

2012 GB3095-

GB 38

38-2002

2.8-2

1	pH	6~9
2	COD _{Cr}	20
3	BOD ₅	4
4	NH ₃ -N	1.0
5	SS	/
6		0.2
7		0.05
8		0.05
9		0.05
10		0.005
11		0.3

GB/T14848-2017

2.8-3

	pH								
	6.5~8.5	/	0.5	0.3	0.1	0.01	1.0	0.005	0.01
	0.05	1.0	250	250	20	1.0	450	1000	

GB3096-2008 2

2.8-4

2	60	50

GB36600-2018

2.8-5

	pH								
	/	60	65	5.7	/	18000	800	38	900

1

GB 1629

7-1996

2.8-6

		1.0

GB 5084-

2005

--	--	--

1	/ mg/L	60	100	40 ^a 15 ^b
2	/ mg/L	150	200	100 ^a 60 ^b
3	/ mg/L	80	100	60 ^a 15 ^b
4	/ mg/L	5	8	5
5			35	
6	pH		5.5~8.5	
7	/ mg/L	1000 ^c	2000 ^c	
8	/ mg/L		350	
9	/ mg/L		1	
10	/ mg/L		0.001	
11	/ mg/L		0.01	
12	/ mg/L	0.05	0.1	0.05
13	/ mg/L		0.1	
14	/ mg/L		0.2	
15	/ /100mL	4000	4000	2 ^a 1 ^b
16	/ /L			

a

b

c

GB

12523-2011

GB 12348-2008 2

2.8-8 2.8-9

70	55

2	60	50

GB18599-2001

2013 36

GB18597-2001

“

[2017]160



GB

1500m

300m

100-150m

1200-

15°-30°

5°-45°

25°

Ñüé3p&\$€

170m

150m

470m

115m

[2018]67

[2018]28

[2019]159

[2018]28

470m

9.28hm²

HPF1860

B=1200mm L=28m V=2.0m/s H=0m

1257m

1160m

50m

1220m

37m

-6°

B=305mm L=28m

V=2.0m/s H=2m

B=75mm L=28m V=2.0m/s H=0m

"

+

"

500m

1

2

3

+1360m

1280m



1

12km

12km 318 318 25km

145km

1200-1500m 300m 100-150m

25° 15°-30° 5°-45°

170m 150m

580m 30 120 470m 20 80 780m

20 80 840m 20 80

115m

2

6.5%

9.75% 15m 5.0m 8m 30cm

 3000m 500m 800m

 1250m 1.08hm²

 1350m

1.21hm²

3

 0.54hm² 1.5~2.0m

 850m

4

 1280m

 0.39hm²

 750m

 2.5km

2.11-1

			470	+140	20	80	GB3095-
			580	+200	30	120	
			780m	+150	20	80	
			840m	+45	20	80	
			1325m	+215	50	200	

		1550m	+200	20	80	2012
		1780m	+70	25	100	
		2130m	+50	12	50	
		1740m	+20	3	12	
	200m		200m			GB3096-2008
						2

115m

2.11-2

			115m		GB3838-2002

3km

“

[2017]160

	500	200m

10000

60

1560m 1170m

390m

891.88

2018 5 2

C5118252018057130146161

60 /

1560m

1170m

390m

0.4448km²

2018 5

2 2028 5 2

6

	X	Y
1	3317623.00	34565722.00
2	3317535.00	34565935.00
3	3316693.00	34566438.00
4	3316336.88	34566034.83
5	3316766.92	34565955.58
6	3316830.39	34565754.65

185°

10km

1655 1735mm

6

9 465mm -3.5 33 1 5.1 7

24.1 15 33.7 283

860

V

1

D_{3s}

P₁

Q₄

D_{3s}

P_{1l}

16 48m

P_{1q}

P_{1m}

Q₄

2

1

2

1 0 2 4 4

400m

1200m

6.37 12.74m

8.96m

325° 10°

1 2 3 4 4

400m

1200m

8.24 13.13m

11.08m

325° 10°

2

95%

<0.01mm

CaO	47.27	55.75%	MgO	0.45	1.61%	SiO ₂	0.56	1.71%
K ₂ O	0.01	0.41%	Na ₂ O	0.02	0.46%	SO ₃	0.01	0.55%

		CaO	47.36	55.21%	MgO	0.36	1.95%	SiO ₂	0.56	2.65%
K ₂ O	0.02	0.39%	Na ₂ O	0.01	0.42%	SO ₃	0.04	0.81%		

3

4

1 6

1560m 1170m

390m

1402m

120m

60m

1270m

1402m 1270m

132m

“

”

1

2

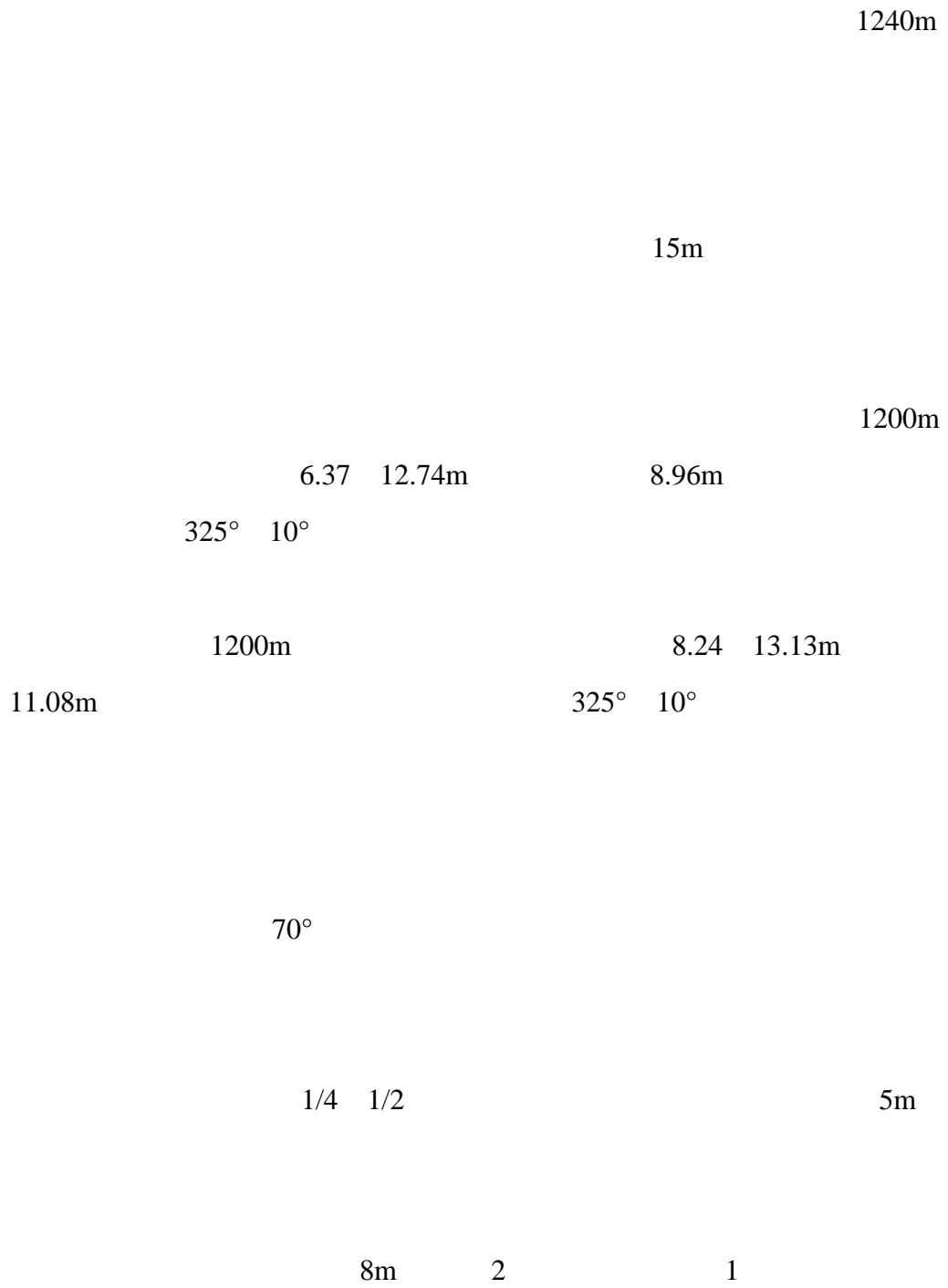



35m

		15m	15m	
			75°	3.80m
	110mm	17.08m	1.50m	4.5m
		1 3		4.0m
4	2	10		7107.75t
	41.61t/m			

200m

3

1270m

1390m

47°

431.24 t

465.3m×198.64m

1

" "

2

15m

75°

60m

120m



3

1

CM351

110mm

25m

75

2

1

1

1000mm

2

15m

15m

75°

3.80m

110mm

17.08m

1.50m

4.5m

4.0m

1 3

4

2

10

7107.75t

41.61t/m

1

EC-240B

2.0m³



20

1280m

1.5km

4

HPF1860

B=1200mm L=28m V=2.0m/s H=0m

1257m

1160m

50m

1220m

37m

-6°

B=305mm L=28m V=2.0m/s H=2m

B=75mm L=28m V=2.0m/s H=0m

1

1

9.28hm²

15~20cm ẽ

1.54 m³

15~20cm

0.17 m³

0.06

m³

0.06 m³

0.40 m³

20cm

6~10m

4.60 m³

1.36 m³

+1265m +1280m

7.80 m³

1.65 m³

2

2014 8

1

1345m 1360

1360m

167.58m

83.24m

1345m

165.6m

65.78m

2

1360m

240073.37m³

1345m

51567m³

3

1

694024.72

1.16

1

2

367094.84

0.61

4

18

3.2-2

		2	4	6	8	10	12	14	16	18
1										
2	1360m									
3	1345m									
4										

		2	4	6	8	10	12	14	16	18
5										

1280m

	8m	2		1
			200m	
1			1270m	
2			1390m	
3		47°		
4		75°		
5		5m		
6			60m	
7			431.24 t	
8	8m	2		1
9			0.591 m ³ /m ³	
10			465.3m×198.64m	
11		200m		

				6.5%
9.75%	15m	5.0m	8m	30cm
	3000m	500m	800m	
2.62hm ²		1250m		1.08hm ²
				1350m
1.21hm ²				
	1280m			
0.39hm ²				
	60.0 t/a	0.15kg/t		
90.0t	300.0kg			
0.5m	5.0m		144.84	m ³
	2014	8		
				9.28hm ²
		15~20cm		1.54 m ³
	15~20cm		0.17 m ³	0.06
m ³		0.06 m ³		0.09 m ³
	1.92 m ³			
0.54hm ²				4m
	21600 m ³			

1

0.3m 0.3m 1 0.5 1700m

130m
100cm 80cm 1 0.75
C20 20cm

M10

0.4m 0.3m 0.3m 0.2m 5‰
2600m

M10

0.4m 0.2m 0.2m

3.3-1

		0.4448km ²			
	333	+	334	891.88	
	t				
	1560m		1170m	390m	
	60	t			

		HPF1860			
		1257m HPF1860 B=1200mm L=28m V=2.0m/s H=0m			
		1257m 1160m 50m 1220m 37m -6° B=305mm L=28m V=2.0m/s H=2m B=75mm L=28m V=2.0m/s H=0m			
					/
		0.54hm ² m ³	4m	21600	
		5.5% 15m	7% 4.5m		
		1.5km			
					/
		200mm 130m ³	400mm		/
			100cm 80cm 1 0.75		/

		C20		
		20cm		
			/	/
	/	150m		
		2m ³		
		5m ³		
		200mm	400mm	
			130m ³	/
		100cm	80cm	
		1	0.75	
		C20	20cm	
		10m ³		
			+	
		90%	+DE	/
		95%		/
				/
				/

		HW08		
			/	/
60		150m	200	
2018 7 18				[2018]17

1560m 1170m 390m
1402m
120m
60m 1270m
1402m 1270m 132m
5% 1.1 60.0 t/a
332 + 333 891.88 t 332 333 1
95% 0.591 1m³/m³ 60.0 t/a
+1360
60 t/a
1000×800×800mm 1000mm

1	CM351	Ø110 mm	2	1
2		/	1	/
3	E750XH	21.2m ³ /min 1.38Mpa	2	1
4		EC-240B	2	/
5		EC-240	1	/
6		20	10	/

7		ZL-50B		1	/
8		T-180		1	/
9		/		1	/
10		5		1	/
11		4		1	/
12		HPF1860 200mm		1	/
13		JC1600 CSS=200mm		1	/
14	CD1 10t10m	10 10		1	/
15		GZG125-4		4	/
16		B=1200mm L=28m V=2.0m/s H=0m		1	/
17		B=1200mm L=75m V=2.0m/s H=2m		1	/
18		B=1200mm L=305m V=2.0m/s H=0m		1	/
19	DE	DE1217		1	/

2011 2013

2011

		/a	12000	
		t/a	90	
		t	54	
		/a	5000	
		t/a	13059	

400mm 200mm

100cm 80cm 1 0.75
C20 20cm

15 8 5 300 20

12.10hm²
1.22hm²

10.88hm²

		9.28		9.28	
		1.09	0.12	1.21	1.08
		0.39		0.39	
		10.76	0.12	10.88	
		0.38	0.16	0.54	
		0.55	0.13	0.68	
		0.93	0.29	1.22	
		11.69	0.32	12.10	

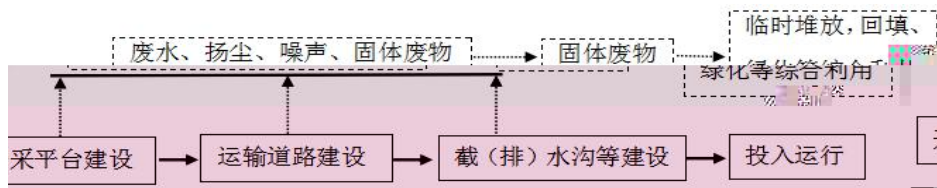

1

CO NO_x

2

3

4

5-1

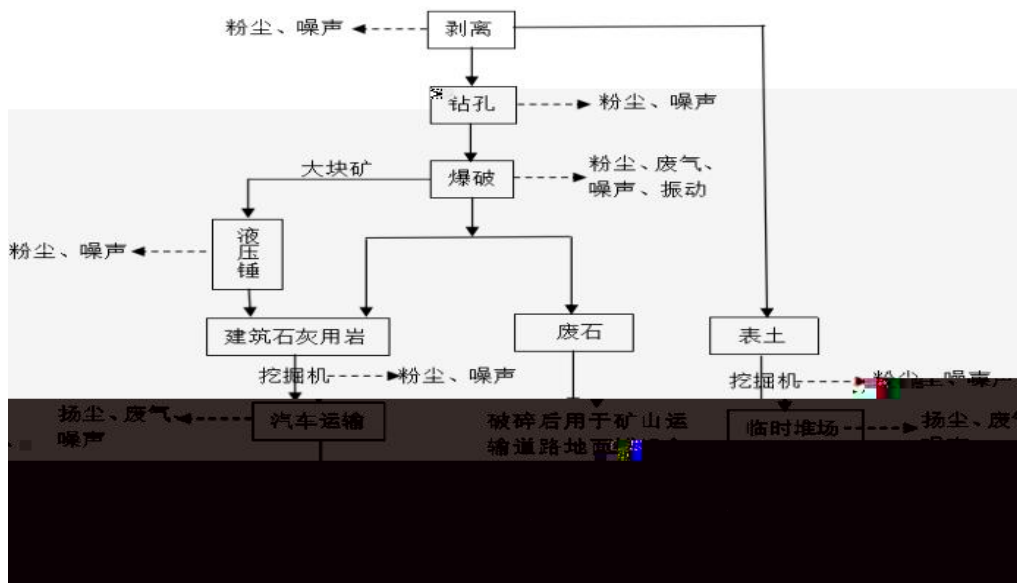



CM³51
75°
110mm
25m

15m
75°
3.80m
15m
110mm
17.08m
1.50m
4.5m
4.0m
1
3
4
2
10
7107.75t
41.61t/m

1
1000mm

EC-240B
2.0m³

HPF1860
B=1200mm L=28m V=2.0m/s H=0m
B=305mm L=28m V=2.0m/s
H=2m
B=75mm L=28m V=2.0m/s H=0m

9.28hm²

15~20cm

1.54 m³

15~20cm

0.17 m³

0.06

m³

0.06 m³

0.09 m³

1.92 m³

0.54hm²

12.10hm² 16cm

		hm ²	
	1.54		
	0.17		
	0.06		
	0.06		
	0.09		
	1.92		
		9.28	1.54
		1.21	0.17
		0.39	0.06
		0.54	0.06

			0.68	0.09
			12.10	1.92

197.11 m³
 1.92 m³ 3.14 m³ 1.92 m³
 ”
 “
 ”
 1

+1345m 1360m 29.15 m³
 0.40 m³

20cm
 6~10m 4.60 m³
 1.36 m³

+1265m +1280m 7.80 m³
 1.65 m³
 2

60.00 t/a
 184.71 m³ 29.15 m³
 155.56 m³

		29.15				0.40	28.75	0
		4.60	0.13		1.36		3.11	0
		7.80	1.65				6.15	0
			1.36	1.36				0

		41.55	3.14	1.36	1.36	0.40	38.01	0
		155.56					155.56	0
		197.11	3.14	1.36	1.36	0.40	193.57	0

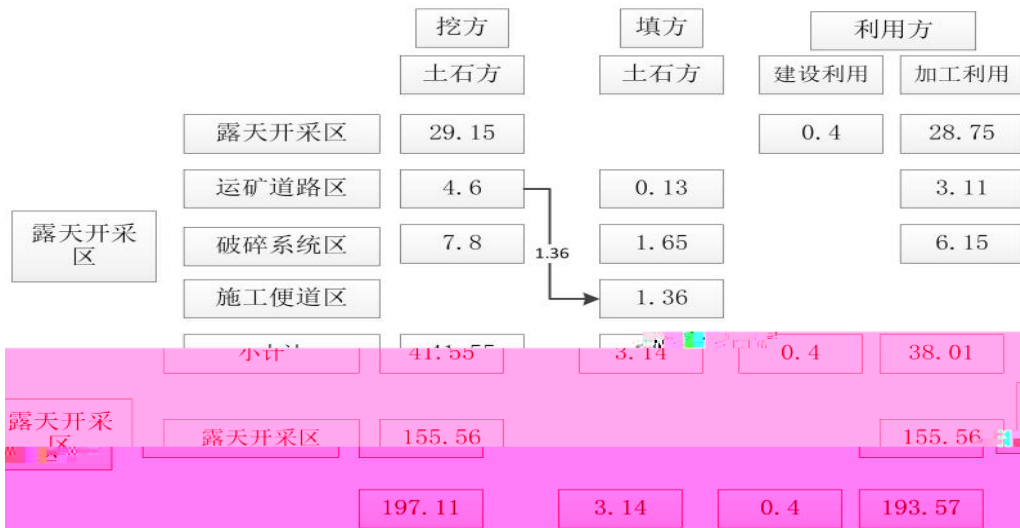

1

7200m² 1.5L/m² · 120m 60m
 10.8m³/d

2

2000t/d 0.018m³/t
 36m³/d

3

100 /d 0.2m³/ 20m³/d
 0.85 17m³/d 5100m³/a SS

1500mg/L

20m³

1

4

20

300

8h

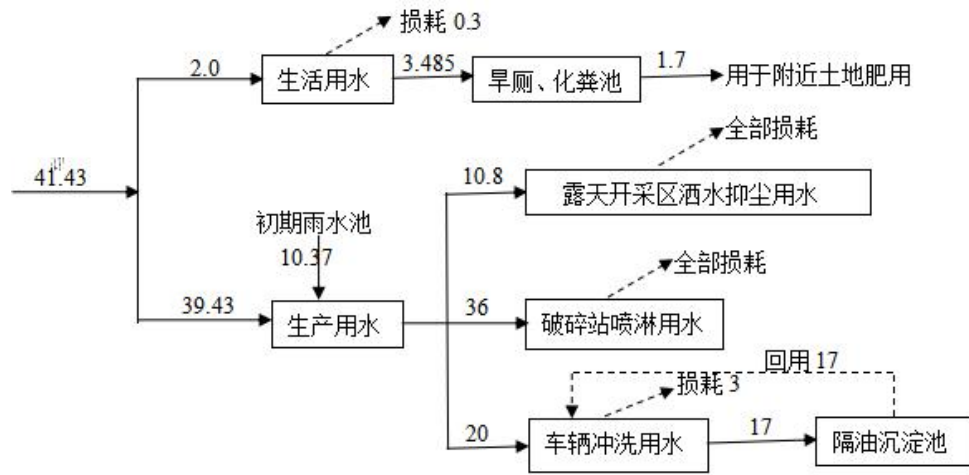

[2013]32

50m TSP 8.90mg/m³ 100m TSP
1.65mg/m³ 120m TSP
GB16297-1996
2
60%
20km/h 0.63kg/km
3 1km
0.002t

	2	50	11.02	1.0	
		150	5.00		
		200	0.9		

0.94m/s

200m TSP

(GB16297-1996)

200m

(GB16297-1996)

3

CO NOx

1			90
2			85
3			90

1

2

0.2kg 10

2kg/d

1

0.0365kg/t(

1.54 m³

1.4t/m³

0.5m 5.0m

2.156 t

0.787t/a

70%

0.236t/a

0.004kg/t

2.4t/a



$$Q = 0.123 \times V/5 \times (W/6.8)^{0.85} \times (P/0.5)^{0.75}$$

Q—— kg/km·

V—— km/h

W—— t/

P—— kg/m²

1500m

100 .

10t

30t

20km/h

	0.102	0.171	0.232	0.288	0.341	0.391
	0.259	0.437	0.592	0.734	0.866	0.996
	0.361	0.608	0.824	1.022	1.207	1.387

0.3kg/m²

24.72kg/d 7.416t/a

80%

1.4832t/a

NO_x CO

NO_x 7.1g/kg CO

19.6g/kg

90t

NO_x 0.6639t/a CO 1.764t/a

N₂O

CO

2

0.15kg/t	0.30kg/t		0.10kg/t	0.35kg/t
	60 t/a			90t/a
		"	+	"
70%			+	90% +DE
		95%		
1.215t/a				

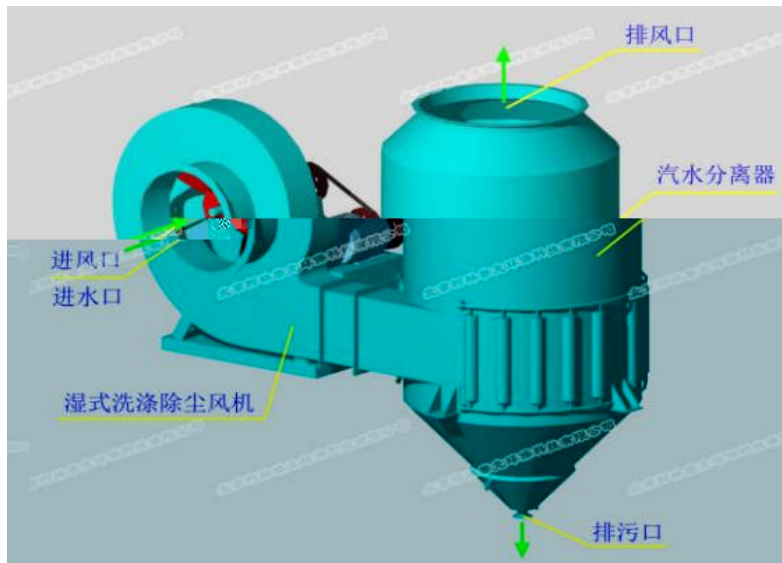

3

54t

GB 17691-2005

III IV V “ IV ”

GB 252-2000

0#

4.3-4

0#	1.5g/L	S×17g/L	2.8g/L	850kg/m ³	0.1%
----	--------	---------	--------	----------------------	------

54t

0.095t/a SO₂

0.0011t/a NO_x

0.178t/a

1

20
 300 8h 100L
 20L/d 80L/d 2.0m³/d 0.85
 1.7m³/d 510m³/a
 2m³
 5m³

2

10 30 min

$$q = 7.622(1 + 0.63 \lg P) / (t + 6.64)^{0.56}$$

$$Q = q \times F \times \Psi$$

q — L/s·hm²

Q — L/s m³/h

P — 2

t — min 15min

F — m² 3600m²

500m²

Ψ — 0.3 0.4

q 270.14L/s·hm²

Q 29.18L/s 105.03m³/h

q

270.14L/s·hm²

Q 5.4L/s 19.45m³/h

15min

31.12m³/

130m³

3

SS

$$Q_m = C Q A 10^{-3}$$

Q_m——

m³/a

C——

0.2

Q——

mm

A——

m²

5400m²

1535.6mm

0.2

4.3-4

	m ²	5400
	m ³ /a	1658.448
	m ³ /d	4.54
	m ³	10

1658.448m³/a

4.54m³/d

pH 6~9

SS

500~800mg/L

800mg/L

SS 1.327t/a

10m³

1

1

			9.28hm ²	
		15~20cm	1.54 m ³	
	15~20cm		0.17 m ³	0.06
m ³		0.06 m ³		0.09 m ³
	1.92 m ³			
	0.54hm ²			

	4m	21600 m ³		
2				
		+1345m 1360m		29.15 m ³
	0.40 m ³			
				20cm
		6~10m	4.60 m ³	
1.36 m ³				
		+1265m +1280m		7.80 m ³
1.65 m ³				
		38.01 m ³		
3				
		100t/a		
	5×5×2m			
4				
	31.12m ³ /	SS	1000mg/L	
80%		24.896kg/	50	1.245t/a
		SS	500~800mg/L	800mg/L
	1.327t/a			
5				

2016

HW08

1.0t/a

5m²

+HDPE

1.5cm

10⁻¹⁰cm/s

GB 18597-2001

5

GB18597-2001

A

B

C

A

B

C

D

E

F

6

20

0.5kg/d

10kg/d

3t/a

1		1.92 m ³		
2		38.01 m ³		
3		100t/a		5×5×2m
4		2.572t/a		
5		3t/a		
6				
7		5.0t		

"

"

1

2

				+HDPE
	-			1.5cm
				10 ⁻¹⁰ cm/s

		-		10~15cm 10 ⁻⁷ cm/s
	-			
	-			

1

2

" "

4.3-8

7.4241t/a

2.4

		COD BOD ₅ SS NH ₃ -N	1.7m ³ /d	
		SS	1.245t/a	
		SS	1.327t/a	
		SS	17m ³ /d 5100m ³ /a	
			1.92 m ³	
			38.01 m ³	
			100t/a	5×5×2m
			2.572t/a	
			5.0t/a	
			3t/a	
			80-130dB A	
			80-85dB A	
			/	

1

2

3



“

”

1

95%



1

2

3

80-110dB A

GB12348-2008 2

GB3096-2008 2

4

HW08

5

98%

1

2

3

4

5

6

7

4.4-1



1

2

3

4

5

1

2

70%

60%

70%

CO₂ H₂O CO NO NO₂

90% +DE

95%

+

“ ”

“ ”

“ ”

VOCs

3

"

"

NO_x



				GB18306-2001	2008	6	
1				0.15g			0.40s
	VII						
						15.6	
	34.8			-1.8		928.2hPa	
	15.5hPa			82.5%		1535.6mm	
		4.1m/s		0.6m/s	5		0.80m/s
12	0.43m/s			ESE		9.7%	
						0.01m/s	2017
	0.90m/s	2010				0.40m/s	
7	24.35	1		5.38		20	
	2017-07-10	36.9	20			016-01-25	-4.4 2013
		16.30	2012			15.00	5
	8		317.41mm	1		27.55mm	20
			2010-08-14	155.3mm		20	
		2005		1733.60mm		1998	
	1272.60mm			7		124.38 h	1
	42.91h			20			2013
		1147.60h	2012			750.80h	2-3
	10			86%	5		77%
11	20					2003	
	86.00%	2015				77.00%	10

109.4km	2047km ²	80.56%	107m ³
	33.65 m ³	3590m	50km ²
12	8	4	
			5km
	15km	174.1km ²	2
		50km ²	
	87.8m ³ /s	27.7 m ³	
	5~10	137m ³ /s	78.7%
4	37.8m ³ /s	21.3%	12
	27.5m ³ /s	10.3%	3
			20h
		2580m ³ /s	626m ³ /s
	114.02		58.21
	49.4	14	55
	21.86		37.71

2018 1 -2018 12

SO₂ NO₂ PM₁₀ PM_{2.5} CO O₃

	9.0	16.8	1.0	119.6	41.5	26.2
	60	40	4	160	70	35

NO₂ PM₁₀ PM_{2.5} SO₂
 GB3095-2012
 CO GB3095-2012
 24 O₃ GB3095-2012
 8

1
 1#
 2
 SO₂ NO₂ TSP PM₁₀
 3
 7
 SO₂ NO₂ TSP PM₁₀
 4

GB3095-2012

SO ₂	2018.06.26	0.013	0.011	0.009	0.008
	2018.06.27	0.011	0.009	0.007	0.010
	2018.06.28	0.009	0.008	0.006	0.007
	2018.06.29	0.012	0.013	0.008	0.006
	2018.06.30	0.008	0.011	0.011	0.016
	2018.07.01	0.009	0.015	0.012	0.010
	2018.07.02	0.014	0.007	0.010	0.007
NO ₂	2018.06.26	0.021	0.024	0.019	0.024
	2018.06.27	0.023	0.023	0.028	0.027
	2018.06.28	0.021	0.026	0.029	0.019
	2018.06.29	0.026	0.025	0.019	0.034
	2018.06.30	0.029	0.029	0.031	0.028
	2018.07.01	0.031	0.033	0.030	0.034
	2018.07.02	0.027	0.028	0.029	0.027
TSP	2018.06.26	0.15			
	2018.06.27	0.17			
	2018.06.28	0.19			
	2018.06.29	0.14			
	2018.06.30	0.09			
	2018.07.01	0.21			
	2018.07.02	0.17			
PM ₁₀	2018.06.26	0.035			
	2018.06.27	0.028			
	2018.06.28	0.031			
	2018.06.29	0.034			
	2018.06.30	0.029			
	2018.07.01	0.033			
	2018.07.02	0.037			

1

GB3095-2012

2

$$P_i = \frac{C_i}{S_i}$$

P_i——iC_i——i (mg/Nm³)S_i——i (mg/Nm³)P_i 1.0P_i

3

		P _{i(max)}			
SO ₂	2018.06.26- 2018.07.02	0.026	0.5	0	
NO ₂		0.17	0.2	0	
TSP		0.7	0.3	0	
PM ₁₀		0.247	0.15	0	

SO₂ NO₂ TSP PM₁₀ P_{i(max)}

1

(GB3095-2012)

1

3

500m

W1

1000m

W2

3500m

W3

2

pH COD BOD₅ NH₃-N SS

11

3

3

1

4

GB 3838-2002

pH		GB 6920-1986	SX836 PH JBJC201610-14	/
COD _{Cr}		HJ 828-2017	YH2016-98951837 COD JBJC201608-40 YH2016-98951864 COD JBJC201608-41	4mg/L
BOD ₅		HJ 505-2009	1081281 JBJC201608-15	0.5mg/L
NH ₃ -N		HJ 535-2009	V722S JBJC201608-64	0.025 mg/L
SS		GB 11901-1989	FA2004B	/

			JBJC201608-10	
		GB11893-89	V722S JBJC201608-64	0.01mg/L
		GB 7475-1987	AA-6880 JBJC201608-03	0.01mg/L
		HJ 694-2014	AFS-9700 JBJC201608-02	0.3μg /L
		GB 7467-87	V722S JBJC201608-64	0.004mg/L
		GB 7475-1987	AA-6880 JBJC201608-03	0.001 mg/L
		GB 11911-89	AA-6880 JBJC201608-03	0.03mg/L

5

pH	7.44	7.47	7.46	7.47	7.45	7.48	7.44	7.48	7.46
COD _{Cr}	13	15	12	17	19	17	18	16	19
BOD ₅	2.5	2.9	3.1	3.3	3.6	3.4	3.7	3.5	3.8
NH ₃ -N	0.17	0.13	0.16	0.22	0.19	0.23	0.24	0.26	0.23
SS	31	28	25	34	35	32	35	39	32
	0.07	0.10	0.08	0.11	0.13	0.09	0.16	0.14	0.16
	L	L	L	L	L	L	L	L	L
	L	L	L	L	L	L	L	L	L
	L	L	L	L	L	L	L	L	L
	L	L	L	L	L	L	L	L	L
	L	L	L	L	L	L	L	L	L

L

2

1

$$S_{ij} = \frac{C_{ij}}{C_{is}}$$

S_{ij}—— i j

C_{ij}—— i j (mg/L)

C_{si}—— i (mg/L)

$$S_{pH,k} = \frac{7.0 - pH_j}{7.0 - pH_{sd}} \quad pH_j \geq 7.0$$

$$S_{pH,j} = \frac{pH_j - 7.0}{pH_{su} - 7.0} \quad pH_j < 7.0$$

pH_j — j pH

pH_{sd} — pH

pH_{su} — pH

$S_{ij} = 1.0$

S_{ij}

2

		6~9	20	4	1	/	0.2
W1	$P_i \max$	0.225	0.9	0.925	0.24	/	0.8
W2	$P_i \max$	0.24	0.95	0.9	0.26	/	0.7
W3	$P_i \max$	0.24	0.95	0.95	0.23	/	0.8
		0.05	0.05	0.05	0.005	0.3	
W1	$P_i \max$	/	/	/	/	/	
W2	$P_i \max$	/	/	/	/	/	
W3	$P_i \max$	/	/	/	/	/	

GB3838-2002

1

1#

500m

2#

2

pH

17

3

1

pH		GB 5750.4-2006	SX836 pH JBJC201610-14)	/
		GB 11892-89	HHS-S6 JBJC201608-42	0.5mg/L
		HJ 535-2009	V722S JBJC201608-64	0.025 mg/L
		GB 11911-89	AA-6880 JBJC201608-03	0.03mg/L
		GB 11911-89	AA-6880 JBJC201608-03	0.01mg/L
		HJ694-2014	AFS-9700 JBJC201608-02	0.3µg /L
		GB 7475-1987	AA-6880 JBJC201608-03	0.05 mg/L
		GB 7475-1987	AA-6880 JBJC201608-03	0.001mg /L
		GB 7475-1987	AA-6880 JBJC201608-03	0.01mg /L
		GB 7467-87	V722S JBJC201608-64	0.004mg/L
		HJ 84-2016	ECO IC JBJC201608-51	0.006mg/L
		HJ 84-2016	ECO IC JBJC201608-51	0.018mg/L
		HJ 84-2016	ECO IC JBJC201608-51	0.007 mg/L
		GB 5750.5-2006	ECO IC JBJC201608-51	0.016 mg/L
		HJ 84-2016	ECO IC JBJC201608-51	0.016 mg/L
		GB 5750.4-2006	0.1ml A /43	1.0mg/L
		GB/T 5750.4-2006	BSA224S JBJC201608-09	/

pH	7.84	7.61
	0.61	0.72
	0.22	0.27
	0.1946	0.2758
	L	L
	L	L
	L	L
	L	L
	L	L
	0.017	0.035
	0.298	0.625
	72.5	61.7
	34.8	9.68
	1.62	2.38
	0.089	L
	309	307
	365	294

L

2

1

$$S_{ij} = \frac{C_{ij}}{C_{sj}}$$

S_{ij} — i j

C_{ij} — i j mg/L

C_{sj} — i mg/L

pH $S_{pH,j} = \frac{7.0 - pH_j}{7.0 - pH_{sd}}$ pH_j 7.0

$S_{pH,j} = \frac{pH_j - 7.0}{pH_{su} - 7.0}$ pH_j 7.0

pH_j — j pH

pH_{sd} — pH

pH_{su} — pH

1

1

2

1#	P _i	0.56	/	0.44	0.649	0.1	0.03	0.05	0.2	1
2#	P _i	0.407	/	0.54	0.919	0.1	0.03	0.05	0.2	1
1#	P _i	0.34	0.298	0.29	0.139	0.081	0.089	0.687	0.365	
2#	P _i	0.7	0.625	0.247	0.039	0.119	$\frac{0.01}{6}$	0.682	0.294	

1

GB/T14848-2017

1

1

4

5.2-9

1#		1m
2#		1m
3#		1m
4#		1m

2

A

3

2018 6 26 6 27

2

1

4

GB3096-2008

-

HJ2.4-2009

2

1

GB3096-2008 2

2

3

5.2-10

1#	56.3	39.2	56.1	39.5	60	50
2#	54.8	37.8	55.3	38.4		
3#	56.2	36.3	56.6	37.1		
4#	54.1	39.4	55.7	40.3		

(GB3096-208) 2

1

1

3

1#

2#

3#

2

pH

9

3

2019 5 21 1

4

5

	pH	6.28	6.35
		13.7	9.84
		7.53	10.6
		2.71	1.05
		11.5	9.38
		14.8	11.5
		5.84	3.66

2

1

GB36600-

2018

2

3

5.2-12

	/	60	65	5.7	/	1800 0	800	38	900
P _{i max}	/	0.228	0.042	/	/	0.357 ×10 ⁻³	0.014	0.279	0.00 5

GB36600-2018

" 7

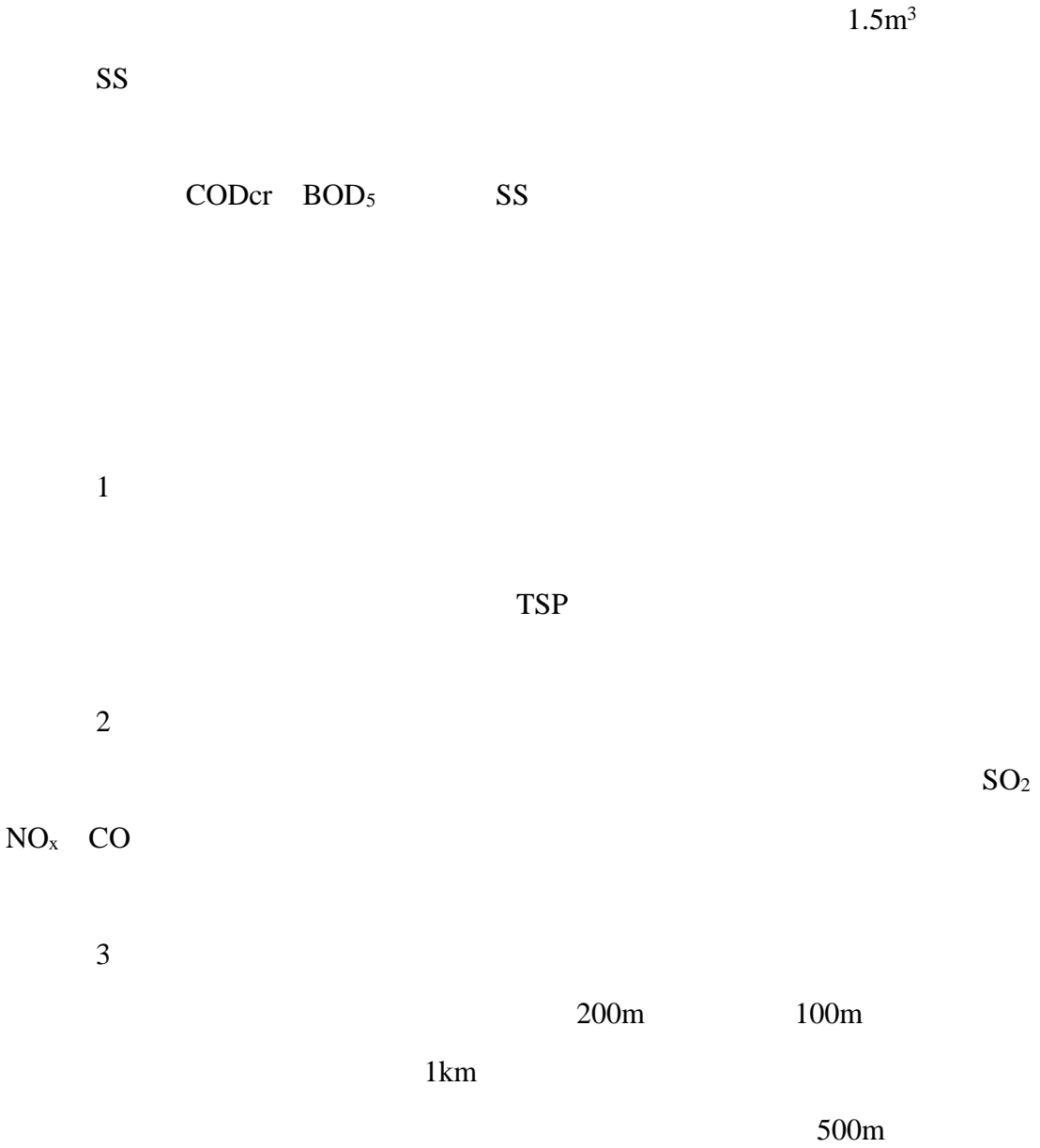

75~80dB A

6.1-1

1		80	5m
2		79	5m
3		80	5m
4		75	5m

$$L_2 = L_1 - 20 \lg(r_2 / r_1) \quad (r_2 > r_1)$$

$$L = L_1 - L_2 = 20 \lg(r_2 / r_1) \quad (r_2 > r_1)$$

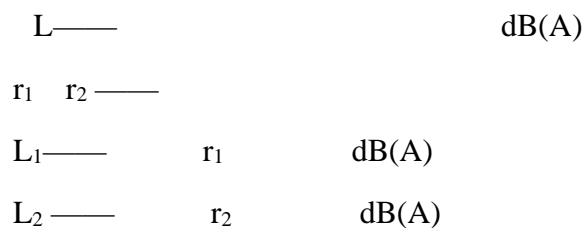

6.1-2

1		80.0	74.0	68.0	61.9	60.0	58.4	55.9	54.0	50.5	48.0	44.4
2		79.0	73.0	67.0	60.9	59.0	57.4	54.9	53.0	49.5	47.0	43.4
3		80.0	74.0	68.0	61.9	60.0	58.4	55.9	54.0	50.5	48.0	44.4
4		75.0	69.0	63.0	56.9	55.0	53.4	50.9	49.0	45.5	43.0	39.4

GB12523-2011

70dB A
55dB A
6.1-2

20m
70dB A

100m
55dB(A)



1

2

1

1 3



1 2

1

7 10m

0.1%

2

3

4

1

" - - "



2

3



15~60m

10~50m

5

1

2

A.

$0.05\text{g}/(\text{m}^2 \cdot \text{d})$

B.

C.

1

1

(HJ2.3-2018)

A

B

2m³

5m³

B

2

(HJ2.3-2018) 5.3.2.2,

B

A

B

1

2

SS

SS

50%

HJ 610-2016

A“

”

“54

”

1

70%

0.787t/a

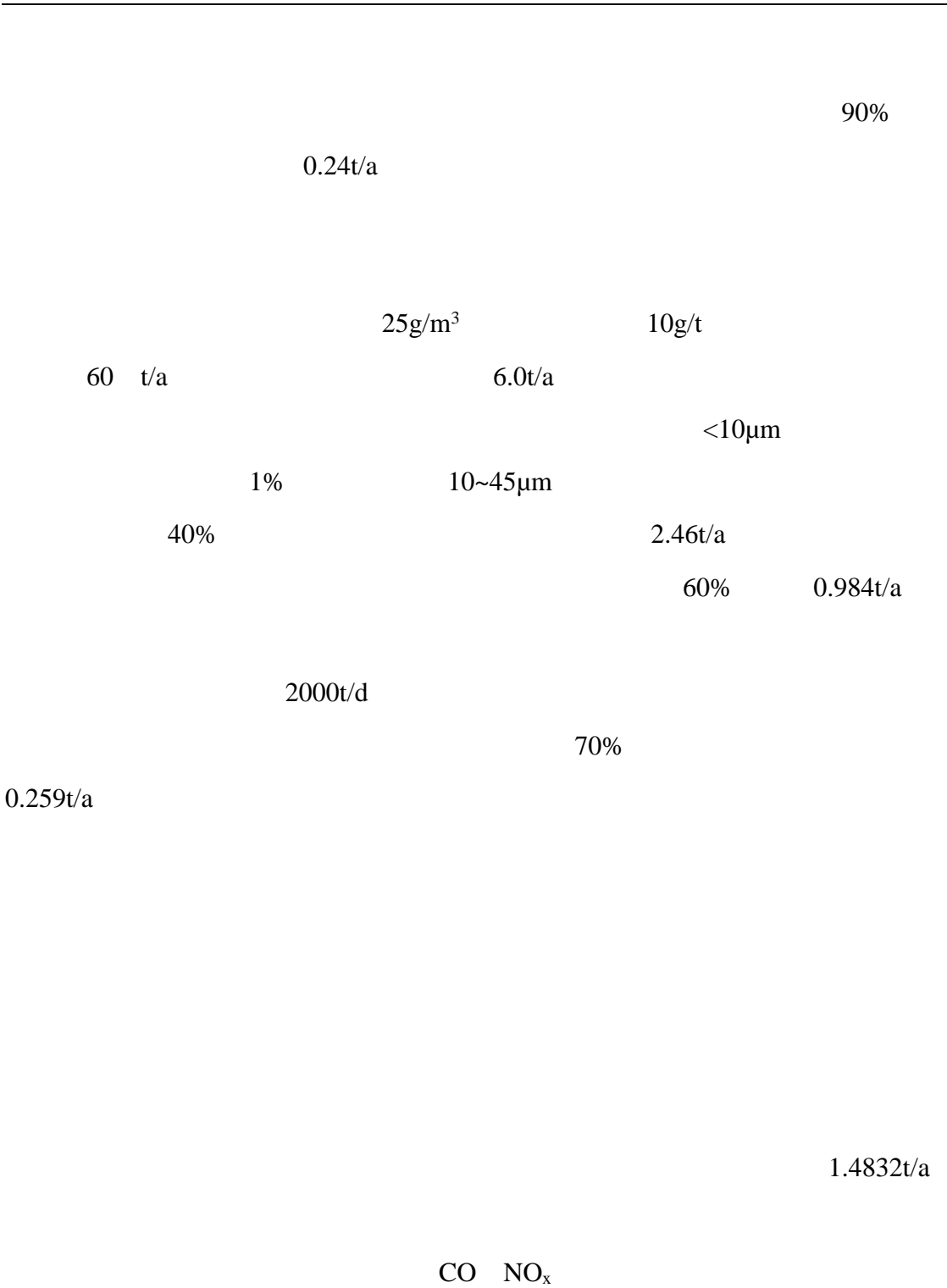

60 t/a

90t/a

" + "

70%

+ 90% +DE

95%

1.215t/a

3

1

20 1998~2017

15.6

34.8

-1.8

928.2hPa

15.5hPa

82.5%

1535.6mm

4.1m/s

0.6m/s

ESE

9.7%

20年风向频率统计图
(1998-2017)
(静风频率: 38.2%)

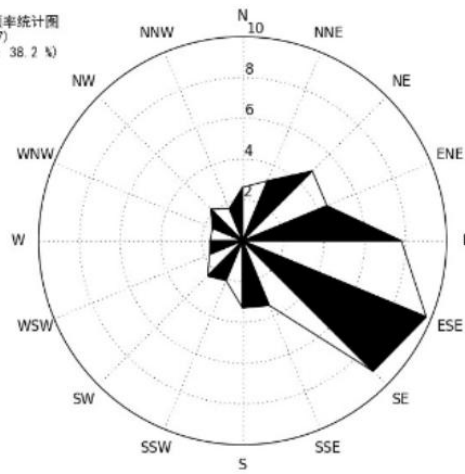

2

		970	375	4	2.011	0.838	0.9
		65	60	8	1.215	0.506	

3

1

		900	GB3095-2012

2

- HJ2.2-2018

Aerscreen

/	/	/
	/	34.8
	/	-1.8
		√
	/m	/
		√
	/km	/
	/°	/

3

--	--

1	10	0.011343	1.26	10	0.027824	3.09
2	25	0.011556	1.28	25	0.0336	3.73
3	50	0.011904	1.32	50	0.043691	4.85
4	75	0.012245	1.36	75	0.051442	5.72
5	100	0.012577	1.4	100	0.052282	5.81
6	125	0.012903	1.43			
7	150	0.013221	1.47	125	0.052679	5.85
8	175	0.013534	1.5	150	0.049338	5.48
9	200	0.013839	1.54	175	0.044965	5.00
10	225	0.014137	1.57	200	0.040241	4.47
11	250	0.014429	1.6	225	0.039878	4.43
12	275	0.014714	1.63	250	0.039779	4.42
13	300	0.014993	1.67	275	0.039369	4.37
14	325	0.015268	1.7	300	0.038761	4.31
15	350	0.015536	1.73	325	0.038007	4.22
16	375	0.015798	1.76	350	0.037144	4.13
17	400	0.016056	1.78	375	0.036204	4.02
18	425	0.016309	1.81	400	0.035262	3.92
19	450	0.016555	1.84	425	0.034256	3.81
20	475	0.016797	1.87	450	0.033269	3.70
21	500	0.017036	1.89	475	0.03231	3.59
22	525	0.017271	1.92	500	0.031339	3.48
23	550	0.017497	1.94	525	0.030396	3.38
24	575	0.017721	1.97	550	0.029495	3.28
25	600	0.017941	1.99	575	0.028612	3.18
26	625	0.018159	2.02	600	0.028105	3.12
27				625	0.027643	3.07
28	650	0.018317	2.04	650	0.02719	3.02
29	675	0.01823	2.03	675	0.026736	2.97
30	700	0.018089	2.01	700	0.026285	2.92
31	725	0.017883	1.99	725	0.025846	2.87
32	750	0.017632	1.96	750	0.025399	2.82
33	775	0.01735	1.93	775	0.024964	2.77
34	800	0.017044	1.89	800	0.024538	2.73
35	825	0.016726	1.86	825	0.024121	2.68
36	850	0.016402	1.82	850	0.023716	2.64
37	875	0.016078	1.79	875	0.023315	2.59
38	900	0.015756	1.75	900	0.022921	2.55
39	925	0.015438	1.72	925	0.022611	2.51
40	950	0.015115	1.68	950	0.022326	2.48
41	975	0.014795	1.64	975	0.022045	2.45
42	1000	0.014486	1.61	1000	0.021761	2.42
43	1025	0.014182	1.58	1025	0.021482	2.39
44	1050	0.013889	1.54	1050	0.021212	2.36
45	1075	0.013604	1.51	1075	0.020945	2.33
46	1100	0.013329	1.48	1100	0.020683	2.30
47	1125	0.013058	1.45	1125	0.020424	2.27
48	1150	0.012795	1.42	1150	0.020168	2.24
49	1175	0.012537	1.39	1175	0.019919	2.21
50	1200	0.01229	1.37	1200	0.019675	2.19

AERSCREEN

Pmax=2.04%

5km

Pmax=5.9%

5km

4

- HJ2.2-2018 “
” ”

1				GB 16297-1996	0.9	2.011
2				2		1.215

1				0.838kg/h	0.5h	4	
2				0.506	1h	2	

HJ 2.2-2018 8.7.5.1 “

	18.328 $\mu\text{g}/\text{m}^3$	646m	
GB16297-1996		1mg/m ³	
53.091 $\mu\text{g}/\text{m}^3$	114m		GB162
97-1996	1mg/m ³		
	AERSCREEN		24h
		GB3095-2012	TSP300 $\mu\text{g}/\text{m}^3$

(GB/T13201-91)

1

GB/T13201-90

$$\frac{Q_c}{C_m} = \frac{1}{A} (BL^C + 0.25 r^2)^{0.50} L^D$$

C_m—— mg/m³

L—— m

r—— m

A B C D——

Q_c—— kg/h

A	<2	400	400	400	400	400	400	80	80	80
	2~4	700	470	350	700	470	350	380	250	190
	>4	530	350	260	530	350	260	290	190	110
	<2	0.01			0.015			0.015		

B	>2	0.021	0.036	0.036
	<2	1.85	1.79	1.79
C	>2			

	SO ₂ +NO _x	2000t/a	500~2000t/a	<500t/a				
		O ₃ CO	SO ₂ NO ₂ PM ₁₀ PM _{2.5}	PM _{2.5} PM _{2.5}				
				D				
				2018				
		AER MOD	AD MS	AUSTAL2000	EDMS /AEDT	CALPUFF		
			50km		5~50km		=5km	
			TSP				PM _{2.5} PM _{2.5}	
		C		100%	C		>100%	
			C		10%	C	>10%	
			C		30%	C	>30%	
	1h		h	C	100%	C	>100%	
			C			C		
			k	-20%		k	>-20%	
		TSP						
		TSP			1			
								m

		SO ₂ t/a	NO _x t/a	t/a	3.226	VOCs t/a
"		"	"	"	"	"

1

V

121

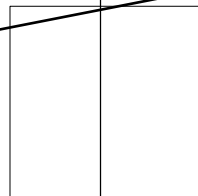

	52.4	46.4	40.4
	58.3	52.3	46.3
	50m		

1
2

50m

GB12348-2008

2

6.2-13

			470m	19.50	53.3	53.3	60	
			780m	19.74	56.1	56.1	60	

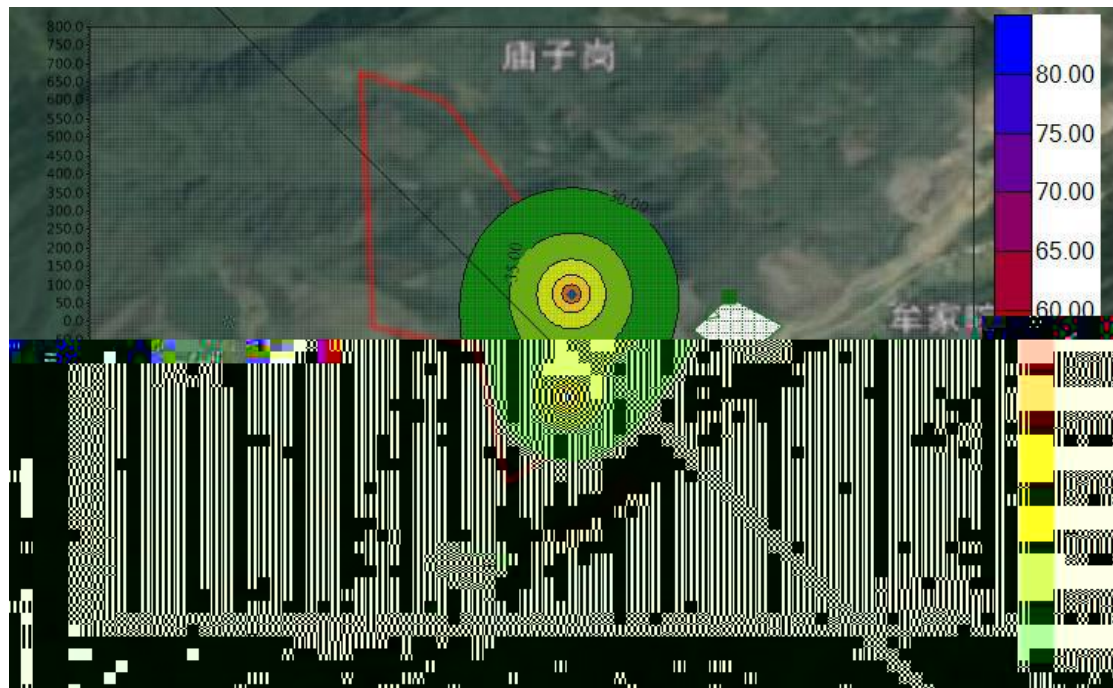

110 dB(A)~130 dB(A)

GB6722-2003

$$V = K \left(\frac{Q^{1/3}}{R} \right)^\alpha$$

V	cm/s	
Q	kg	13.5kg
R		m
K		150
		1.5

6.2-14

6.2-15

1	0.016	
2	0.016~0.21	
3	0.21~0.64	
4	1.6	
5	1.6	

1	1.0~6.0	
2	7.3	
3	10	
4	10.2~12.7	
5	12~14	
6	16	
7	6.0~20	
8	22.8	

	100	150	160	200	300	400	500	600
	0.551	0.300	0.272	0.195	0.106	0.069	0.049	0.038
	700	800	900	1000	1500	2000	2500	3000
	0.030	0.024	0.020	0.017	0.009	0.006	0.004	0.003

470m

HW08

HJ 964-2018

pH

5.5~8.5

HJ 964-2018

A

" "

		44.48		hm ²		
		a	b	c	d	
						C

		E	F			
		a)	b)	c)		
		a)	b)			
	pH	5.5~8.5				
		HJ 964-2018	A	"	"	
1	"	"	"	"	"	"
2						

1

15

“ ”

“ ”

1 “ ”

“ ”

0.5m

0.4m

30%

2

3

5

60

“

”

5

“ ”

1

;

2

3

4

5

1

[2016]21

5

6

20~ 30cm

7

85%

85%

3~5

“

MSDS

+

E1	+			
E2				
E3				
+				

P

B

M

C

Q

P

E

D

E

HJ 169-2018

1

	+			
A				

5km

6.4-3

		470m	20	80	GB3095-2012
		580m	30	120	
		780m	20	80	
		840m	20	80	
		1325m	50	200	
		1550m	20	80	
		1780m	25	100	
		2130m	12	50	
		1740m	3	12	
HJ 169-2018					D

" 5km

1 500m 500

200m 100 "

E3

115m

6.4-4

			115m		GB3838-2002

HJ 169-2018 D

F3 S3

E3

HJ 610-2016 A“

” “54 ”

E3

GB12268-2012

GB18218-2009

54t

	Diesel oil	
C ₄ H ₁₀₀ ~C ₁₂ H ₂₆	CAS	68334-30-5
-18	282-338	
KPa	MPa)	
	KJ/mol	30000—46000

1 0.70—0.75	
75-120	55
% V/V 0.6	% V/V 6.5
mj	MPa
	LD50 >5 000mg/kg LC50 >5 000mg/m ³ /4h(
MAC mg/m ³ TVL-TWA	MAC mg/m ³ TVL-STEL

GB18218-2018

HJ/T 169-2018

6.4-6 6.4-7

		W5.4 W5.2	W5.1 3	5000t	1.5t	0.0008
						pi=0.0008

				2500t	54t	0.0006
						pi=0.0006

6.4-6 6.4-7

GB18218-2018

HJ/T 169-2018

qi/Qi<1

P

Q

$$Q = q_1/Q_1 + q_2/Q_2 + \dots + q_n/Q_n$$

$q_1 \quad q_2 \dots q_n$ ——— t

$Q_1 \quad Q_2 \dots Q_n$ ——— t

Q 1

Q 1 Q 1 1 Q 10 2 10 Q 100 3 Q 100

54t

1.5t

B

2500t

Q 1

C.1

M

M4

P

P4

E

HJ 169-2018

D

E3

E3

E3

E3

2008 8 1 0 45

45

1

492

2011 2 27 6 45



6

2

4 6

10

470m

580m

1

1200m

0.54hm

4m

1.54 m³

500m

0.5~1.0 ×10⁻⁴ / .

0 20cm

50cm

20m²

10m³



HSE

1

2

3

4

5

6

7

8

6.4-8

1		
2		
3		
4		
5		
6		
7		
8		
9		
10		
11		

1

1

1

3

2



1

2

1

2

6.4-1

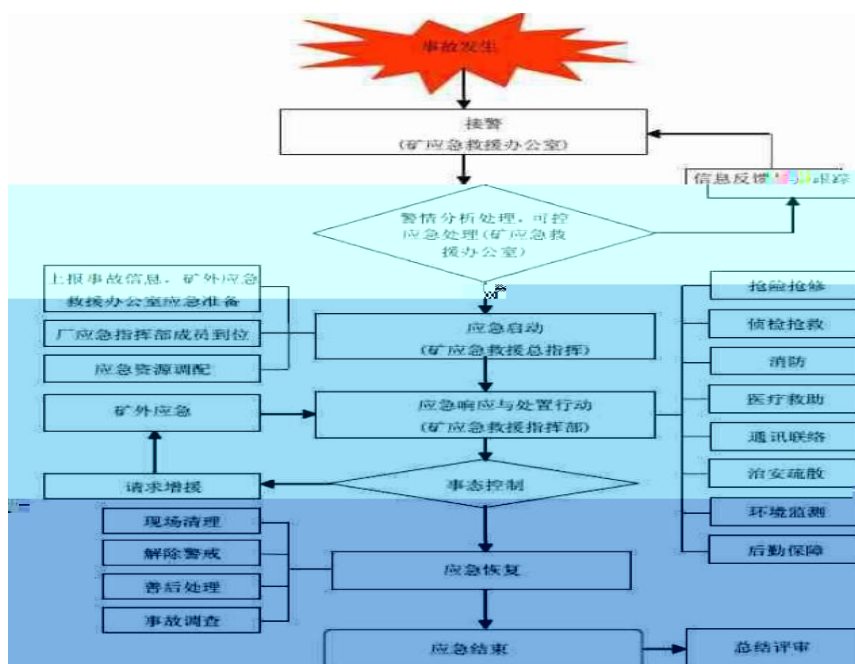

52

6.4-9

		50
		2
	/	52

	/t	1.5							
		500m	80		5km	1			
		200m							
			F1	F2	F3				
			S1	S2	S3				
			G1	G2	G3				
			D1	D2	D3				
	Q	Q 1	1 Q 10	10 Q 100	Q 100				
	M	M1	M2	M3	M4				
	P	P1	P2	P3	P4				
		E1	E2		E3				
		E1	E2		E3				
		E1	E2		E3				
	+								
					/				

		SLAB	AFTOX	
			-1	_____ m
			-2	_____ m
			_____	_____ h
			_____	_____ d
			_____	_____ d
		"	"	"
		"	"	"



[2018]135



7.1-1

--	--	--	--

1			
2			
3			
4			/
5			/
6			
7			

3km

	500	200m

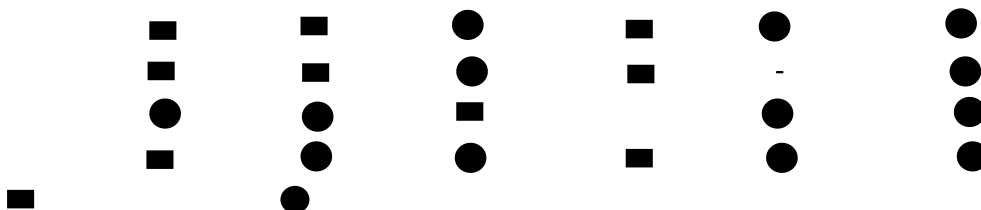

HJ19-2011



1

1~2

10m×10m

3m

5m×5m

1m×1m

GPS

2

3



4

5

GPS

6

1

Excel

2

RS

GPS

GIS

2001.12

“

”

600 1300m

1300 1800m

1800 2300m

2300 2600m

2600 3400m

3400 4400m

1980

1500m —

1500 2000m — 2000 2700m — 2700

3600m — 3600 3900m — 3900 4400m

4400m

1170-1560m

4 7

			1. Form.Itea ilicifolia
			2. Form.Cyclobalanopsis glaucoides
			3. Form.Broussonetia papyrifera
			4. Form.Alnus nepalensis
			5. Form.Carya cathayensis
			6. Form.Quercus variabilis
			7. Form.Tetracentron sinense
			8. Pinus yunnanensis
			9. Form.Keteleeria evelyniana
			10.
			11. Form.Debregeasia longifolia
			12. Form.Litsea rubescens
			13. -
			14. Form.Coriaria nepalensis
			15. Form.Desmodium racemosum
			16. Form.Bauhinia brachycarpa var. microphylla
			17. Form.Pteridium revolutum
			18. Form.Imperata cylindrica
			19. Form.Neyraudia reynaudiana

62

4 12 27 6 15 43 1 3 5 1 3 5

4 6 9

	12	27	62
	1	3	5
	1	3	5
	6	15	43
	4	6	9

1

10cm

2

2m

" "

3

13-15cm

Pica pica

;

435 460

4

30

1800

5

1

11.69hm²



2

3

Ecosystem Productivity

NPP

Miami

Miami

$$Y_t = 3000 / (1 + e^{1.315 - 0.119t}) \quad Y_p = 3000 * (1 - e^{-0.000664p})$$

Yt—

t—

Yp—

p—

e—

Miami

Shelford

Liebig

	15.6	1535.6	1896.41	1917.82	1896.41	

15.6

Miami

1896.41g/m²·a

1535.6mm

Miami

1917.82g/m²·a

4

3

1170-1560m

6~10

1896.41g/m²·a

1535.6mm

1917.82g/m²·a

505t/km²·a



2

1

2

	36.2	46.5%		27	50.6%		13.9	46.0%
9.1	32.5%							

3



3
1

7 10m

0.1%

2

3

4

1

“ - - ”



2

3



15~60m

10~50m

5

1

2

A.

0.05g/(m²·d

B.



C.

1

2



10%

10%

1%



1

2

30-60°

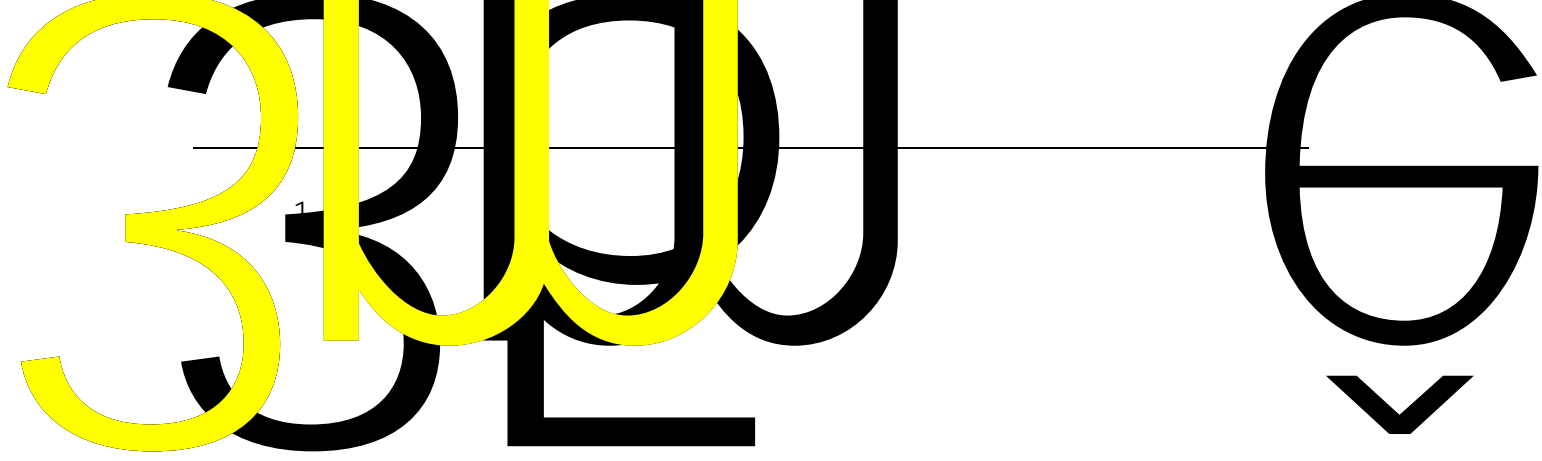

2

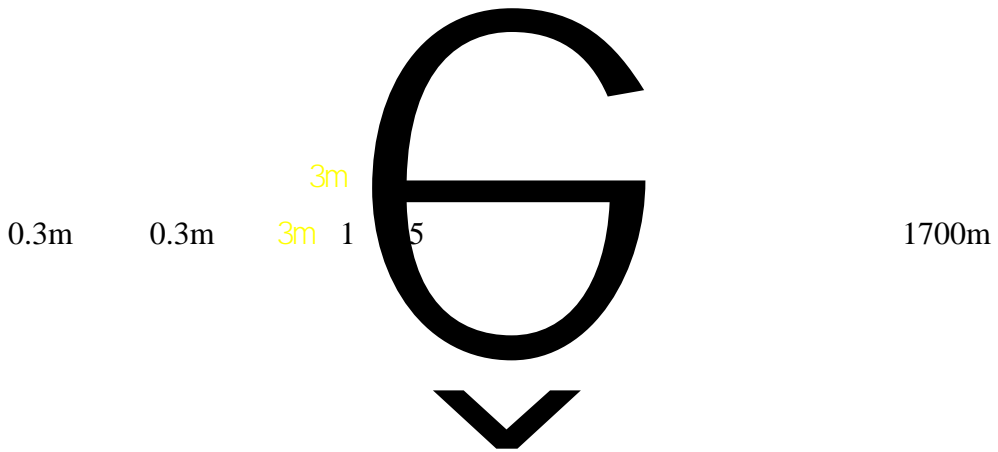

i

2600m

M10

0.4m

0.2m

0.2m

1

65

35

1

2

1m

30×30×30cm

2

1

9.28hm²

1.54 m³

2

80cm

0.4×0.4×0.4m

3m 111

/hm²

1:1

80kg/hm²

3					
1					
				0.3m	1.21hm ²
2					80cm
	0.4×0.4×0.4m		3m	111	/hm ²
			1:1		
80kg/hm ²					
4					
1					
				0.3m	0.39hm ²
	0.39hm ²		0.06	m ³	
2					80cm
	0.4×0.4×0.4m		3m	111	/hm ²
			1:1		
80kg/hm ²					
5					
1					
				0.3m	0.54hm ²



	0.54hm ²	0.06 m ³		
2				80cm
	0.4×0.4×0.4m	3m 111		/hm ²
		1:1		
80kg/hm ²				
6				
1				
			0.3m	0.68hm ²
2				80cm
	0.4×0.4×0.4m	3m 111		/hm ²
		1:1		
80kg/hm ²				
1				
2				
	9.28hm ²			
3				
	1.21hm ²			
4				
	0.39hm ²			

5

0.54hm²

6

0.68hm²

1

1200~1500m

1

"

"

45m

1.5m

25m 1m

45~120cm

2

"

"

— —
— —

2~3cm

5 6

9

2

1000kg/hm²

"

"

SO₂ NO_x CO



" + "

GB16297-1996

1mg/m³

1

20

300

8h

100L

20L/d

80L/d

2.0m³/d

0.85

1.7m³/d 510m³/a

2m³

5m³

150m

30

250

100L/d

3m³/d

0.8

2.4m³/d

1.7m³/d

4.5m³/d

2

SS



0.3m 0.3m 1 0.5 1700m

130m³

1

2

SS

10m³

1

3

100 /d

0.2m³/

20m³/d

0.85

17m³/d 5100m³/a

SS

1500mg/L

20m³

1



1

2

SS

SS

50%

1

80-110dB A

GB12348-2008 2

GB3096-2008 2

2

100m

100m

GB3096-2008 2

100m

3

8:00-11:00

3:00-5:00

1

9.28hm²
15~20cm 1.54 m³
15~20cm 0.17 m³ 0.06
m³ 0.06 m³ 0.09 m³
1.92 m³
0.54hm²
4m 21600 m³

2

38.01 m³

3

100t/a

5×5×2m

4

31.12m
80%
SS
1m

181
U'f



“

”

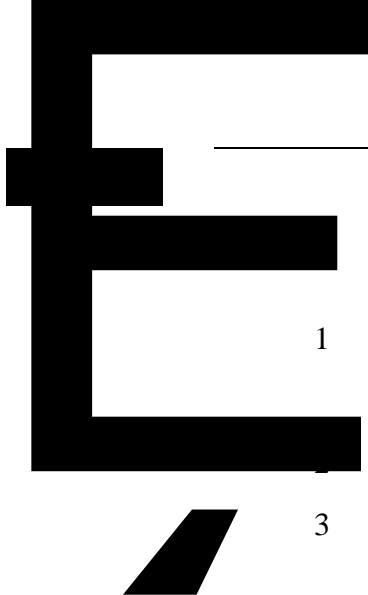

1

3

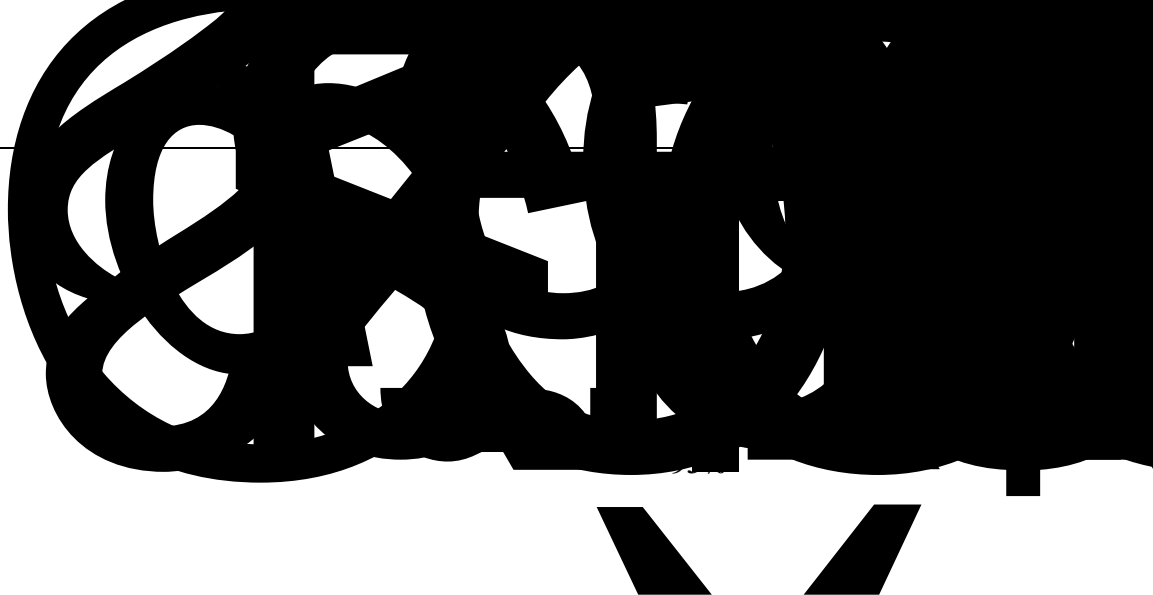

3

“

”

0.2~0.3m

4

0.3m

10000

145

1.45%

8.4-1

			2.0
			2.0
			5.0
			2.0
			5.0



90% +DE	+	95%	20.0
2m ³			1.0
			25.0
	20m ³		5.0
			3.0
			20.0
			1.0
			/
			/
			/

2011

992.52km²

41.52%

294.75×104t

2970t/(km²•a)

1.742mm

49.47% 30.15% 12.23%

8.14%

(SL190-2007)

505t/km²•a

			°				
		9.28	<25	>90		450	41.76
		1.21	<25	>85		450	5.45
		0.39	<20	>90		450	1.76
		0.54	<10	>50		1000	5.40
		0.68	<10	>50		1000	6.80
		12.1				505	61.16

4.2.1

“

”

29.°73 89.6

102.°00 36.7

12.10hm²

10.88hm²

1.22hm²

9.28hm²

1.21hm²

0.39hm²

0.54hm²

0.68hm²

9.3-1

		9.28		9.28	
		1.09	0.12	1.21	1.08hm ²
		0.39		0.39	
		10.76	0.12	10.88	
		0.38	0.16	0.54	
		0.55	0.13	0.68	
		0.93	0.29	1.22	
		11.69	0.41	12.10	

<

>

[2014]1723

12.10hm²

12.10hm²

		9.28		9.28

	1.21		1.21	[2014]1723
	0.39		0.39	
		0.54	0.54	
		0.68	0.68	
	10.88	1.22	12.10	

1

2

3

4

5

			M10		
		0.4m	0.2m	0.2m	
	0.06	m ³			
2	2m ³			0.8~1.0m ³	
				0.06	m ³
	650		0.39hm ²		
			1.54	m ³	0.17
	0.06	m ³	0.09	m ³	
				0.06	m ³
					1.92
m ³				4m	1
2	3	0.4m	1.2m	0.6m	
0.54hm ²			0.3m×0.3m	1	0.5
	0.06	m ³	08m ³	115m ³	
0.54hm ²	0.06	m ³	900	0.54hm ²	
				0.09	m ³
m ³	0.68hm ²				0.09

		0.8×1.0mC20	m	130
			m ³	167
		C20	m ³	77
			m ³	1.54
			hm ²	9.28
				15500
				3400
			m ³	1.54

			m	1700
			m ³	425
		0.3×0.4mM10	m	2600
			m ³	286
		M10	m ³	520
			m	6
			m ³	5
			m ³	0.17
			hm ²	1.21
				2020
				5160
			m ³	0.17
		0.2×0.4mM10	m	230
			m ³	23
		M10	m ³	58
			m	2
			m ³	2
			m ³	0.06
				650
			hm ²	0.39
			m ³	0.06
			m ³	0.06
				900
			hm ²	0.54
			m ³	0.06
			m ³	308
			hm ²	0.54
			m ³	115
			m ³	0.09
			hm ²	0.68
			m ³	0.09

2015 139

2009 187

[2009]187

1

16

2

2000 12

3

2006 16

4

2006 2015

2006 186

5

2015 139

6

GB/T22490-2008

7

SL190-2007

8

GB/T16453.1-16453.6-1996

9

TB/T15774-1995

10

SL342-2006

11

[2009]187

1

2

3

4

6

5

6

1

12.10hm²

12.10hm²

1

1		1	
2		1	
3			
4		1	
		1	
2			

5

-
- 1 1#
 - 2 2#
 - 3 3#
 - 4 4#
 - 5 5#

[2018]135

- 1
- 2
- 3



4

5



“ ”

ISO14000

“ ”

“ ”

1

2

3

4

5

6

7

2

1

1

“

”

2

3

4

5

6

7

“

” “

”

8

9

10

“ ”

1~2

ISO14001



- 1
- 2
- 3

1			20m 2	2 /	GB16297-1996
2		A (Leq	4	2 /	GB12348-2008 2

		2m ³	2m ³	
		20m ³	20m ³	
				60dB A
				50dB A
		HW08	HW08	
		1		
		2		
		HJ/T394-2007		—



1.45%

145 10000

20 /t 10000 60 t

1200 12.2 /t 732

468

1

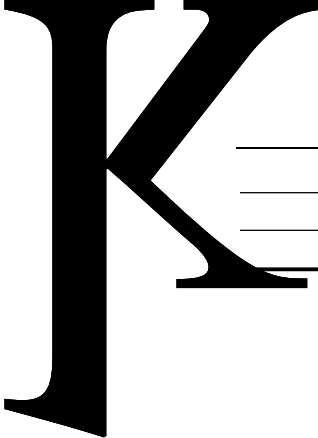

	120
	588

90

CO₂

(Whittaker

Liken

720g/m²·a

1

60kg

44.48hm²

720g

=

2018 5 2

C51182520180571301461

61

60 /

0.4448

10

SO₂ NO₂ TSP PM₁₀

GB3095-2012)

(GB3838-2002)

1

GB/T14848-2017

GB3096-2008

2

1

70%

60%

70%

CO₂ H₂O CO NO NO₂

90% +DE

95%

+

2

3

80-110dB A



GB12348-20 2

GB3096-2008 2

4



/

95%



"

"

NO_x

145

1.45%

1

2

3